

## 汽车继电器 Automotive Relay

10/20A

### 特性 / FEATURES

- 20A触点切换能力  
Switching capability up to 20A
- 具有六种触点形式  
Six different contact arrangements
- 印制电路板式引出端  
Standard PCB layout

**RoHS**  
Compliant

### 订购信息 / ORDERING INFORMATION

## SLE-12VDC-S L-C

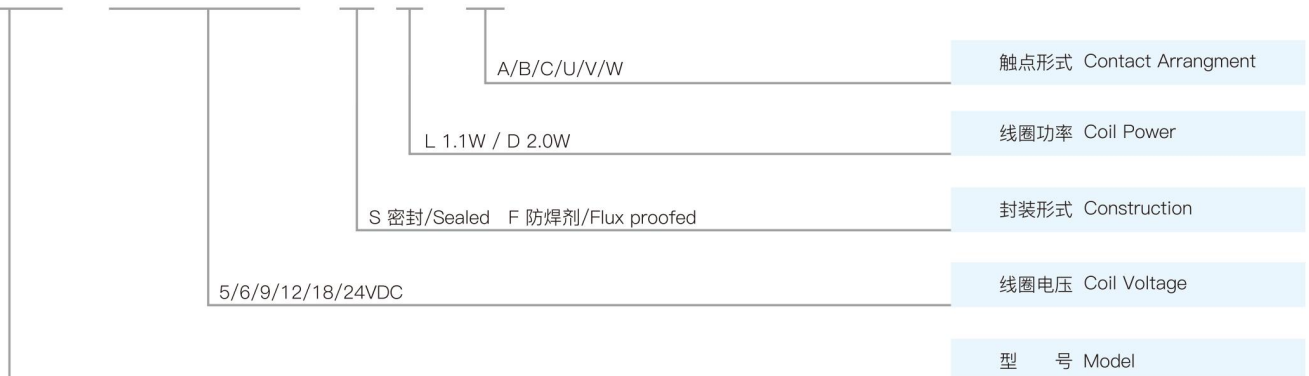

### 触点参数 / CONTACT PARAMETERS

触点形式	Contact arrangement	A / B / C / U / V / W
接触压降(10A下测量)	Voltage drop (at 10A)	≤200mV
触点材质	Contact material	银合金/Silver alloy: AgSnO <sub>2</sub> In <sub>2</sub> O <sub>3</sub> 、AgSnO <sub>2</sub> 、AgNi
触点负载	Contact rating	A, B, C: 10A/120VAC, 28VDC 20A/14VDC U, V, W: 2x10A/120VAC 28VDC 2x20A/14VDC
最大切换电压	Max switching voltage	75VDC 380VAC
最大切换电流	Max switching current	20A
电耐久性 (频率:每小时1800次)	Electrical endurance (Frequency:1800 ops/h)	1x10 <sup>5</sup> ops/1x10 <sup>4</sup> ops
机械耐久性 (频率:每小时18000次)	Mechanical endurance (Frequency:18000 ops/h)	1x10 <sup>7</sup> ops

### 特性参数 / CHARACTERISTICS PARAMETERS

绝缘等级	Insulation level	B/F	
绝缘电阻	Insulation resistance	100MΩ(500VDC)	
介质耐压 (漏电流 1mA)	Dielectric strength (Leakage current 1mA)	线圈与触点间 Between coil and contacts	1000VAC 1分钟/minute
		断开触点间 Between open contacts	500VAC 1分钟/minute
吸合时间(额定电压下)	Operate time(at nominal voltage)	≤10ms	
释放时间(额定电压下)	Release time (without diode)(at nominal voltage)	≤5ms	
湿度	Humidity	5% ~ 85% RH	
环境温度(°C)	Ambient temperature	-40°C ~ +85°C/+105°C	
抗冲击	Shock resistance	100m/s <sup>2</sup> 11ms	
抗振动(双振幅)	Vibration resistance (Double amplitude)	10Hz~55Hz 1.5mm	
重量	Weight	约/Approx 12g	
封装形式	Construction	密封/Sealed 防焊剂/Flux proofed	

备注: 以上数据均为初始值  
Remark: All above data is initial value

### 线圈参数 / COIL PARAMETERS

常温/At (23°C)

功耗(W)	Power consumption(W)	1.1W(L)						2.0W(D)					
		5	6	9	12	18	24	5	6	9	12	18	24
额定电压(VDC)	Nominal voltage(VDC)	5	6	9	12	18	24	5	6	9	12	18	24
线圈电阻(Ω±10%)	Coil resistance(Ω±10%)	22.7	32.7	73.6	130.9	294.5	523.6	12.5	18	40.5	72	162	288
吸合电压(Max)	Pick-up voltage(Max)	75% 额定电压(Nominal voltage)											
释放电压(Min)	Drop-out voltage(Min)	10% 额定电压(Nominal voltage)											
允许最大电压(VDC)	Max allowable overdrive voltage(VDC)	130% 额定电压(Nominal voltage)											

### 安全认证(相关认证以第三方认证证书为准) / SAFETY APPROVAL RATINGS

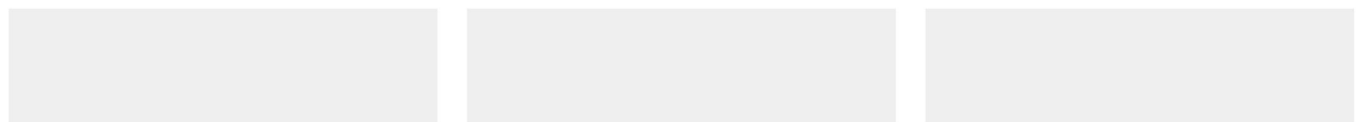

### 外形图 / OUTLINE DIMENSIONS

单位/Unit(mm)

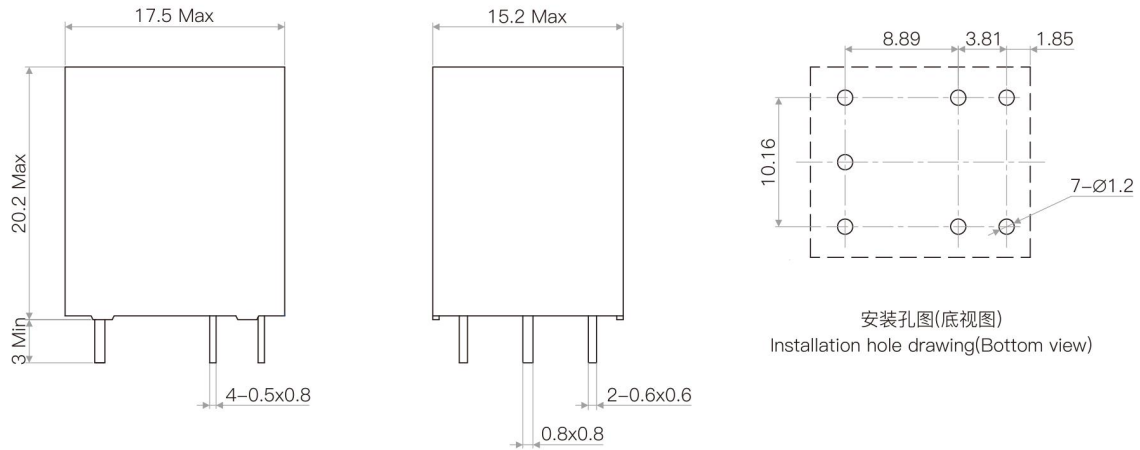

未注公差/Tolerance:±0.1

### 线路图(底视图) / WIRING DIAGRAM (BOTTOM VIEW)

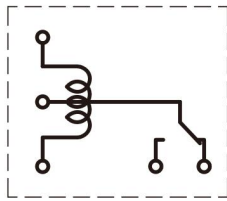

转换C型/Conversion C type

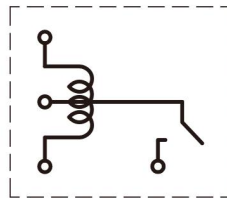

常开A型/Normally open A type

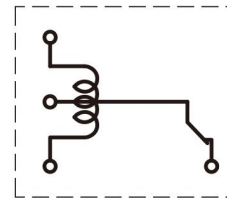

常闭B型/Normally closed B type

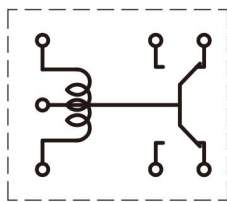

转换W型/Conversion W type

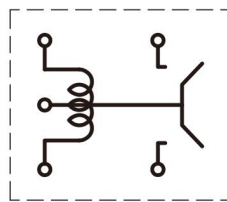

常开U型/Normally open U type

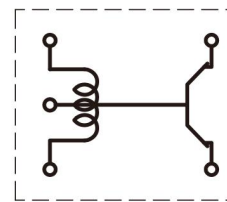

常闭V型/Normally closed V type

### 性能曲线图 / CHARACTERISTIC CURVES

电耐久性曲线  
Electrical endurance curve

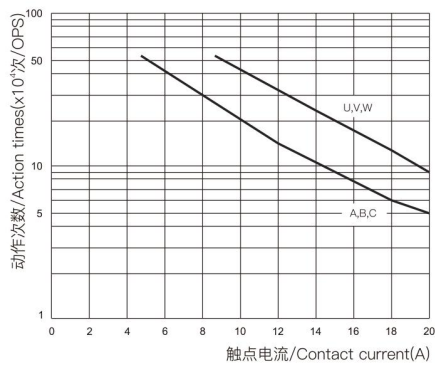

线圈温升  
Coil temperature rise

